

BATTERY



BLUETOOTH LITHIUM IRON PHOSPHATE

12V 200Ah

Version 1.1

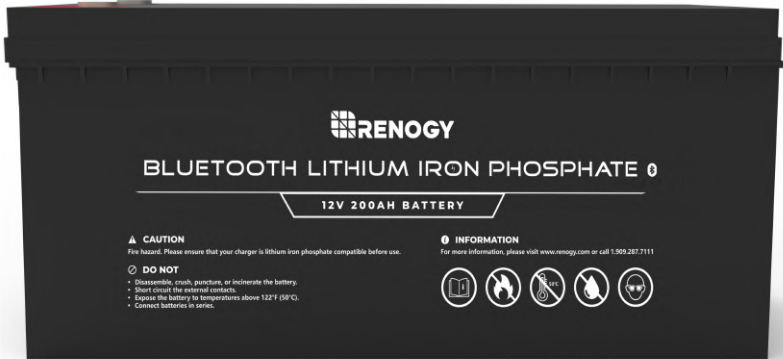

Important Safety Instructions

Please save these instructions.

This manual contains important installation, operation, and maintenance instructions for the Lithium Iron Phosphate Battery w/ Bluetooth. Please observe these instructions and keep them located near the battery for further reference. The following symbols are used throughout the manual to indicate potentially dangerous conditions or important safety information.

WARNING

Indicates a potentially dangerous condition. Use extreme caution when performing this task.

CAUTION

Indicates a critical procedure for the safe and proper installation and operation of the battery.

NOTE

Indicates a procedure or function that is important to the safe and proper installation and operation of the battery.

Disclaimer

The manufacturer accepts no liability for any damage caused by:

- Force majeure including fire, typhoon, flood, earthquake, war, and terrorism.
- Intentional or accidental misuse, abuse, neglect or improper maintenance, and use under abnormal conditions.
- Improper installation, improper operation, and malfunction of a peripheral device.
- Contamination with hazardous substances or radiation.
- Alterations to the product without express written consent from the manufacturer.

General Safety Information

WARNING

- Please keep the battery away from water, heat sources, sparks, and hazardous chemicals
- DO NOT puncture, drop, crush, burn, penetrate, shake, or strike the battery.
- DO NOT open, dismantle, or modify the battery.
- DO NOT touch any terminals or connectors.
- DO NOT touch the exposed electrolyte or powder if the battery casing is damaged.
- Uncovered electrolyte or powder that has contacted the skin or eyes **MUST** be flushed out with plenty of clean water immediately. Seek medical attention afterwards.
- Please make sure any battery charger or charge controller has been disconnected before working on the battery.
- DO NOT connect or disconnect terminals from the battery without first disconnecting loads.

CAUTION

- DO NOT place tools on top of the battery.
- Please keep the battery out of the reach of young children.
- Please wear proper protective equipment when working on the battery.
- Please use insulated tools when working on the battery.
- DO NOT wear jewelry or other metal objects when working on or around the battery.
- Please ensure adequate and secure mounting of the battery.
- Please use suitable handling equipment for safe transportation of the battery.
- DO NOT dispose of the battery as household waste. Please use recycling channels in accordance with local, state, and federal regulations.

Tabel of Contents

General Information	04
Key Features	04
Product Overview	05
Identification of Parts	05
Dimensions	05
Additional Components	06
Preparation	06
Battery Installation	06
Inspection	06
Sizing Cables	07
Connecting Batteries in Bank	07
Securing Cable Connections	08
Installation Environment	09
Battery Operation	09
Activating Battery	09
Charging Battery	09
Discharging Battery	10
Battery Maintenance	10
Inspection	10
Cleaning	10
Checking Voltage	11
Battery Storage	11
Battery Management System	12
Warning and Protection	12
Battery Cell Balancing	13
Troubleshooting	14
Specifications	15

General Information

The Renogy Lithium Iron Phosphate Battery w/ Bluetooth is designed for the drop-in replacement of deep-cycle lead-acid batteries with its standard BCI group size. Weighing only half of the lead-acid counterparts, the battery can be safely discharged to 100% DOD (Depth of Discharge), delivering twice the energy. Manufactured with automotive grade battery cells, the battery features the highest safety standards and an extended cycle life. Hosting intelligent software, the advanced BMS (Battery Management System) provides comprehensive protection to the battery. The built-in Bluetooth module enables remote monitoring on mobile devices in real time.

■ Key Features

- **Easy Upgrades**

Upgrades to lithium seamlessly with the standard BCI group size but a greater energy density, a deeper discharge capability, a higher round-trip efficiency, and a faster charging speed.

- **Uncompromising Quality**

Ensures an exceptional lifespan with more than 2000 cycles (80% DOD), a continuous discharge current of 200A, and a wide range of operation temperatures with the automotive grade battery cells.

- **Reliable System**

Features multi-level protection and precise balancing with the intelligent battery management system.

- **Real-Time Monitoring**

Monitors the battery operation status on mobile devices in real time with the built-in Bluetooth module.

Product Overview

Identification of Parts

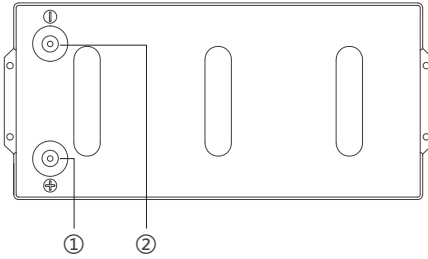

- ① Positive Terminal
- ② Negative Terminal

Dimensions

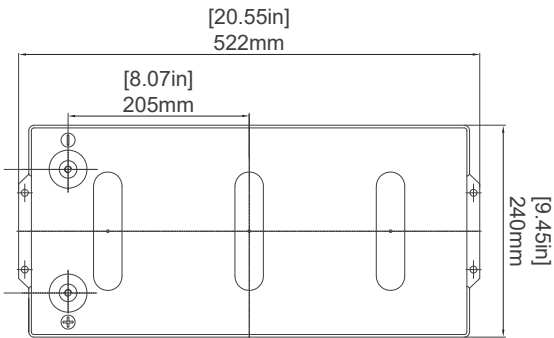
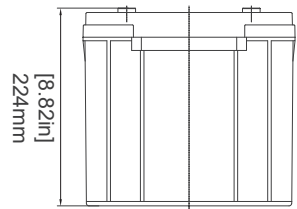
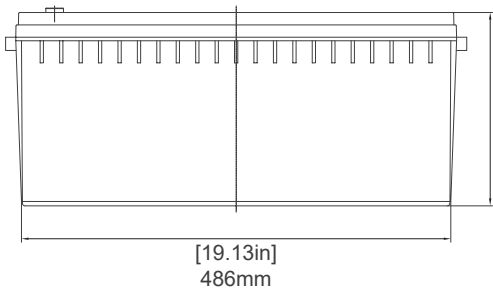

Additional Components

● Long Terminal Bolts (2)

The Long Terminal Bolts (M8x1.25x20mm) are used to secure multiple cable lugs on a single battery terminal

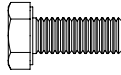

Preparation

Before the installation and operation of the battery, it is recommended to have the following equipment or tools available:

- Proper Protective Equipment
- Insulated Tool(s)
- Multimeter
- Battery Cable
- Battery Charger/Charge Controller

Battery Installation

Safe and reliable installation requires trained and certified technicians. Therefore, the purpose of this section is only to serve as a guideline as all scenarios cannot be covered.

WARNING

- DO NOT short-circuit the battery terminals. Doing so can cause current bursts and lead to irreversible damage to the system and the battery.
- Please verify the polarity before connecting the wiring. Reversing polarity can and will destroy the battery.
- Please use circuit breakers, fuses, or disconnects appropriately sized by a certified electrician, licensed installers, or regional code authorities to protect all electrical equipment.

Inspection

Please check for visible damage including cracks, dents, deformation, and other visible abnormalities. The top of the battery and terminal connections should be clean, free of dirt and cor-

rosion, and dry. If any problems are detected with the battery, please contact us for assistance. Refer to the last page of the manual for contact information.

■ Sizing Cables

Battery cables (sold separately) should be appropriately sized to handle the expected load. Please refer to the following table for the ampacities of copper cables with different gauge sizes.

Copper Cable Gauge Size (AWG/mm ²)	Ampacity (A)
14 (2.08)	20
12 (3.31)	25
10 (5.25)	35
8 (8.36)	50
6 (13.3)	65
4 (21.1)	85
2 (33.6)	115
1 (42.4)	130
1/0 (53.5)	150
2/0 (67.4)	175
4/0 (107)	230

The above values are from the NEC Table 310.15(B)16 for copper cables rated at 75°C (167°F), operating at an ambient temperature of no more than 30°C (86°F). Lengths in excess of 6 feet (1829 mm) may require heavier gauge cable to avoid excess voltage drop in under-sized wiring.

■ Connecting Batteries in Bank

WARNING

- DO NOT connect batteries in series. Doing so can cause catastrophic failure.

CAUTION

- DO NOT connect batteries with different chemistries, rated capacities, nominal voltages, brands, or models in parallel.
- Please avoid excessive voltage difference between parallel connected batteries to avoid triggering the over-current protection.
- The cables between each parallel connected battery should be of equal length to ensure that all batteries can work equally together.
- DO NOT connect more than 8 batteries in parallel.

To connect multiple batteries in parallel, first connect the Positive Terminals of the batteries to each other. Then, connect the Negative Terminals of the batteries to each other. Finally, connect the Positive Terminal of the first battery and the Negative Terminal of the last battery to the system. This type of arrangement is used to increase the overall battery capacity while keeping the battery voltage the same.

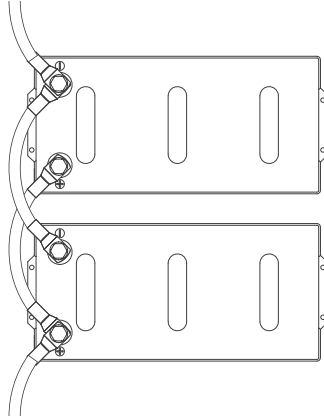

■ Securing Cable Connections

CAUTION

- Please secure all cable connections to the proper specification in order to ensure good contacts between the cable lugs and the battery terminals. Over-tightening cable connections can cause terminal breakage and loose cable connections can cause terminal meltdown or fire.
- Please use an insulated wrench to tighten the cable connections.

To ensure good contacts between the cable lugs and the battery terminals, please use the appropriate number of washers to allow for as much thread engagement as possible without bottoming out the terminal bolt. The correct number of washers can be determined by hand-tightening the terminal bolt with just the cable lug in place and observing the gap that is present. Use the number of washers needed so that the washer stack is slightly larger than the observed gap.

It is important to ensure that the cable lug and the top surface of the terminal are in contact. The washer(s) must be placed on top of the lug. Do not place the washer(s) between the battery terminal and the cable lug as this can cause high resistance and excessive heating.

NOTE

- Please use the included Long Terminal Bolts when needed to secure multiple cable lugs on a single battery terminal.

Installation Environment

The battery should be installed in a clean, cool, and dry place, keeping water, oil, and dirt away from the battery. The accumulation of these materials on the battery can cause current leakage, resulting in self-discharge and a possible short-circuit. Sufficient air flow must be provided to prevent excessive heat build-up and to minimize temperature variation between the paralleled connected batteries.

Battery Operation

CAUTION

- DO NOT overcharge or overdischarge the battery.
- DO NOT charge the battery at low temperatures below 0°C (32°F) and discharge the battery at high temperatures above 140°F (60°C).

Activating Battery

The battery is shipped in shelf mode. Before using the battery for the first time, please activate the battery with a charge/discharge current greater than 1A and measure the terminal voltage to validate. Prior to long periods of storage, please disconnect the battery from the system. The battery will enter shelf mode automatically after 24 hours. In shelf mode, the battery has a low self-discharge rate and can hold the charge for a longer period of time.

NOTE

- Parallel connected batteries can be activated simultaneously with a charge/discharge current greater than 1A for each battery.

Charging Battery

CAUTION

- DO NOT exceed the maximum continuous charge current of the battery.
- Only charge the battery with a battery charger or charge controller that is compatible with the lithium iron phosphate battery.

NOTE

- Depending on the length of time between manufacturing and shipping, the battery may be received at a partial state of charge (SOC). Please fully charge the battery prior to the initial use.

During the standard charging process, the battery is first charged at a constant current of 60A

until the battery voltage reaches 14.4V. Then, the battery is charged at a constant voltage of 14.4V while tapering the charge current. The standard charging process is considered complete when the charge current is less than 10A. However, leaving the battery on float will continue to balance the battery cells and will not damage the battery. The standard charging process normally takes 3.5 hours. Safe charging requires battery temperatures between 32°F and 131°F (0°C and 55°C).

■ Discharging Battery

CAUTION

- DO NOT exceed the maximum continuous discharge current of the battery.
- DO NOT connect large loads to the battery when it is running low
- If the battery shuts off due to low state of charge (SoC), please disconnect the battery from loads and charge the battery as soon as possible. Failure to do so may cause irreversible damage to the battery.
- It is recommended to pair the battery with discharge equipment featuring low voltage disconnect.

During the standard discharging process, the battery is discharged at a constant current of 60A until the battery voltage reaches 10V. Safe discharging requires battery temperatures between -4°F and 140°F (-20°C and 60°C).

Battery Maintenance

■ Inspection

Please perform regular inspections following the steps below:

- Examine the external appearance of the battery. The top of the battery and terminals should be clean, dry, and free of corrosion.
- Check battery cables and connections. Replace any damaged cables and tighten any loose connections.

CAUTION

- Terminal corrosion may adversely affect the battery performance and present a safety hazard. Please keep terminals free of corrosion.

■ Cleaning

Please clean the battery at regular intervals following the steps below:

- Disconnect the battery from the charging source and/or loads.

-
- Clean the top of the battery and terminals with a damp cloth or non-metallic brush. A household cleaner may be used if the battery is extremely dirty.
 - Dry the battery with a clean cloth and keep the area around the battery clean and dry.
 - Ensure the battery is completely dry before reconnecting it to the charging source and/or loads.

■ Checking Voltage

Please check the battery voltage periodically to assess battery health. If the battery is unable to be activated with a charge/discharge current greater than 1A or the battery is activated with a resting voltage below 10V, the battery may have been severely overdischarged due to self-discharge or parasitic loads. Please stop using the battery until the fault can be corrected and the battery can be charged.

Battery Storage

Please follow the tips below to ensure that the battery emerges from storage in a good condition:

- Charge the battery to 30%~50% and disconnect it from the system.
- Store the battery in an open, well ventilated, dry, clean area with temperatures between -13°F~149°F (-25°C~65°C).
- Handle the battery carefully to avoid sharp impacts or extreme pressure on the battery casing.
- Charge the battery at least once every 3~6 months to prevent overdischarge.
- Fully charge the battery when it is taken out of storage.

CAUTION

- DO NOT expose the battery to extreme temperatures over 149°F (65°C).
- DO NOT expose the battery to heat sources.
- DO NOT expose the battery to direct sunlight, moisture, or precipitation.

Battery Management System

Warning and Protection

The battery contains a battery management system (BMS) that warns the user and protects the battery from overvoltage, undervoltage, overcurrent, short circuit, high temperature, and low temperature. Please refer to the following table for the triggering and recovery condition of each warning and protection.

Battery Operation Status		Condition	
Battery Overvoltage	Protection	Trigger	Battery Voltage \geq 14.8V
		Recover	Battery Voltage \leq 13.8V/ Discharge Current \geq 1A
Battery Cell Overvoltage	Protection	Trigger	Battery Cell Voltage \geq 3.7V
		Recover	Battery Cell Voltage \leq 3.45V/ Discharge Current \geq 1A
Battery Undervoltage	Warning	Trigger	Battery Voltage \leq 12V
		Recover	Battery Voltage \geq 12.4V/ Charge Current \geq 1A
	Protection	Trigger	Battery Voltage \leq 10V
		Recover	Battery Voltage \geq 12.4V/ Charge Current \geq 1A
Battery Cell Undervoltage	Warning	Trigger	Battery Cell Voltage \leq 3.0V
		Recover	Battery Cell Voltage \geq 3.1V/ Charge Current \geq 1A
	Protection	Trigger	Battery Cell Voltage \leq 2.5V
		Recover	Battery Voltage \geq 3.1V/ Charge Current \geq 1A
Charge High Temperature	Warning	Trigger	Battery Temperature \geq 122°F (50°C)
		Recover	Battery Temperature \leq 113°F (45°C)
	Protection	Trigger	Battery Temperature \geq 131°F (55°C)
		Recover	Battery Temperature \leq 113°F (45°C)
Discharge High Temperature	Warning	Trigger	Battery Temperature \geq 131°F (55°C)
		Recover	Battery Temperature \leq 122°F (50°C)
	Protection	Trigger	Battery Temperature \geq 131°F (60°C)
		Recover	Battery Temperature \leq 122°F (50°C)
Charge Low Temperature	Warning	Trigger	Battery Temperature \leq 44.6°F (7°C)
		Recover	Battery Temperature \geq 50°F (10°C)

Battery Operation Status		Condition	
Charge Low Temperature	Protection	Trigger	Battery Temperature \leq 32°F (0°C)
		Recover	Battery Temperature \geq 41°F (5°C)
Discharge Low Temperature	Warning	Trigger	Battery Temperature \leq 14°F (-10°C)
		Recover	Battery Temperature \geq 23°F (-5°C)
	Protection	Trigger	Battery Temperature \leq -4°F (-20°C)
		Recover	Battery Temperature \geq 1.4°F (-17°C)
Charge Overcurrent	Warning	Trigger	Charge Current \geq 120A
		Recover	Charge Current \leq 110A
	Primary Protection	Trigger	Charge Current \geq 220A (Delay 15s)
		Recover	Charge Current \leq 110A (Delay 1min)/ Discharge Current \geq 1A
	Secondary Protection	Trigger	Charge Current \geq 240A
		Recover	Charge Current \leq 110A (Delay 1min)/ Discharge Current \geq 1A
Discharge Overcurrent	Warning	Trigger	Discharge Current \geq 220A
		Recover	Discharge Current \leq 200A
	Primary Protection	Trigger	Discharge Current \geq 230A (Delay 15s)
		Recover	Discharge Current \leq 200A (Delay 1min)/ Charge Current \geq 1A
	Secondary Protection	Trigger	Discharge Current \geq 240A
		Recover	Discharge Current \leq 200A (Delay 1min)/ Charge Current \geq 1A
Short Circuit	Protection	Trigger	Discharge Current \geq 2000A
		Recover	Remove Short Circuit (Delay 1min)/ Charge Current \geq 1A

NOTE

- The warning status can only be monitored on the DC Home app.
- The warning status will not affect the normal operation of the battery. But it is recommended to pay closer attention to the battery to avoid triggering protections.

Battery Cell Balancing

The battery employs bypass circuit to maintain the balance between each battery cell group. Each battery cell group is connected with a bypass resistor and a switch in parallel. During the charging process, if the highest-voltage battery cell group reaches the set balancing starting voltage and the voltage difference between the highest-voltage and the lowest-voltage battery cell group exceeds the set voltage difference, the switch connected to the highest-voltage

battery cell group will be closed to shunt the charge current around the highest-voltage battery cell group through the bypass resistor until the voltage difference drops below the set value. To avoid excessive energy loss, the battery cell balancing is only performed during the charging process.

Troubleshooting





If any problems occur during the battery operation, please refer to the following instructions or contact us for assistance:

- If the battery is unable to be activated with a charge/discharge current greater than 1A or the battery is activated with a resting voltage below 10V, the battery may have been severely overdischarged due to self-discharge or parasitic loads. Please revive the battery with a battery charger or charge controller featuring lithium battery activation or force charging.
- If the battery voltage is 0V, the internal fuses may have blown due to severe over-current. Please contact us for assistance.
- If the battery shuts off due to undervoltage protection, please disconnect the battery from loads and charge the battery with a current greater than 1A as soon as possible.
- If the battery cuts off the charge current due to overvoltage protection, please disconnect the battery from the charging source and discharge the battery with a current greater than 1A as soon as possible. If the problem persists with a lithium iron phosphate compatible charging source and the correct voltage setting, please first reduce the charge voltage by 0.2V~0.4V to balance the battery cells for 6 hours before attempting to fully charge the battery again.
- If the battery temperature gets too high/low during the operation and triggers the high/low temperature protection, please disconnect the battery from the charging source and/or loads and cool down/warm up the battery. The battery will automatically recover from the high/low temperature protection and continue operating.
- If too high a current passes through the battery and triggers the charge/discharge over-current protection, please disconnect the battery from the charging source/loads as soon as possible. The battery will automatically recover from the charge/discharge over-current protection after 1 minute. If the charge/discharge over-current protection is triggered 3 times in a row, the battery will no longer recover automatically. Please discharge/charge the battery with a current greater than 1A to recover the battery from the charge/discharge over-current protection.
- If the battery is shorted and triggers the short circuit protection, please remove the short circuit as soon as possible and charge the battery with a current greater than 1A. The battery will automatically recover from the short circuit protection.

Specifications

General	
Battery Cell Type	Lithium Iron Phosphate
Rated Capacity (0.3C, 25°C)	200Ah
Nominal Voltage	12.8V
Voltage Range	10V~14.8V
Cycle Life (0.5C, 25°C)	2000 Cycles (80% DOD)
Dimension	20.55 x 9.45 x 8.62 inch 522 x 240 x 219 mm
Weight	60.2 lbs. / 27.3 kg
Connection Method	Parallel
Terminal Bolt Size	M8 x 1.25 x 15 mm
Recommended Terminal Torque	88.5 inch·lbs ~106.2 inch·lbs / 10 N·m ~12 N·m
Protection Rating	IP65
Communication Protocol	Modbus
Certification	MSDS, UN38.3, FCC, CE, RoHS, UKCA, PSE
Operation Parameters	
Charge Voltage	14.4V
Maximum Continuous Charge Current	100A
Maximum Continuous Discharge Current	200A
Charge Temperature Range	32°F~131°F (0°C~55°C)
Discharge Temperature Range	-4°F~140°F (-20°C~60°C)
Storage Temperature Range	-13°F~149°F (-25°C~65°C)
Operation Relative Humidity	10%~95%

Renogy reserves the right to change the contents of this manual without notice.



US |  5050 S. Archibald Ave, Ontario, CA 91761, USA
 909-287-7111
 www.renogy.com
 support@renogy.com

CN |  苏州高新区科技城培源路1号5号楼-4
 400-6636-695
 <https://www.renogy.cn>
 support@renogy.cn

JP |  <https://www.renogy.jp>
 supportjp@renogy.com

CA |  <https://ca.renogy.com>
 supportca@renogy.com

AU |  <https://au.renogy.com>
 supportau@renogy.com

UK |  <https://uk.renogy.com>
 supportuk@renogy.com

DE |  <https://de.renogy.com>
 supportde@renogy.com